

CDT9013-ME

TRANSISTOR

Marking: J3

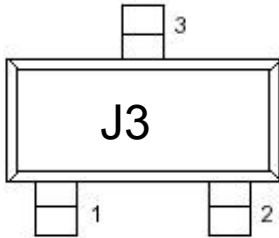

Top view

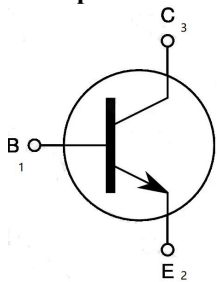

SOT-23 Dimension

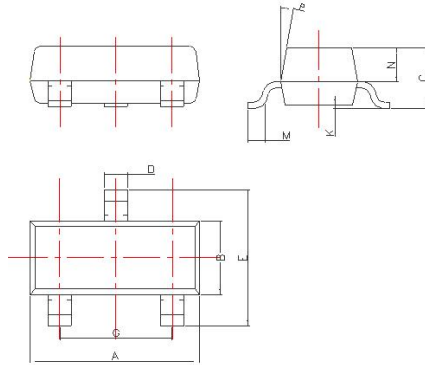

DIM	Millimeters
A	2.85~3.04
B	1.30±0.10
C	1.00±0.10
D	0.45±0.05
E	2.25~2.55
G	1.90±0.1
K	0.00-0.10
M	0.20 min
N	0.60±0.10
P	7±2°

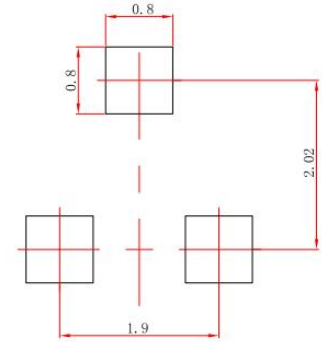
SOT-23
Suggested Layout

mm(±0.05mm)

MAXIMUM RATINGS (Ta=25°C)

Characteristic	Symbol	Rating	Unit
Collector-Emitter Voltage	V_{CEO}	40	Vdc
Collector-Base Voltage	V_{CBO}	30	Vdc
Emitter-Base Voltage	V_{EBO}	5.0	Vdc
Collector Current - Continuous	I_C	500	mAdc
Base Current	I_B	50	mAdc

THERMAL CHARACTERISTICS

Characteristic	Symbol	Max	Unit
Collector Power Dissipation	P_c	300	mW
Junction and Storage Temperature	T_j , T_{stg}	150 , -55 ~150	°C

CDT9013-ME

TRANSISTOR

ELECTRICAL CHARACTERISTICS (Ta=25°C unless otherwise noted)

Characteristic	Symbol	Test Condition	Min	Type	Max	Unit
Collector Cutoff Current	I_{CBO}	$V_{CB}=35V, I_E=0$	--	--	0.1	μA
Emitter Cutoff Current	I_{EBO}	$V_{EB}=5V, I_C=0$	--	--	0.1	μA
Collector-Emitter Breakdown Voltage	$V_{(BR)CEO}$	$I_C=1.0mA$	30	--	--	V
Collector-Base Breakdown Voltage	$V_{(BR)CBO}$	$I_C=100\mu A$	40	--	--	V
Emitter-Base Breakdown Voltage	$V_{(BR)EBO}$	$I_E=100\mu A$	5	--	--	V
DC Current Gain	$h_{FE}(1)$	$V_{CE}=1V, I_C=100mA$	200	--	350	--
	$h_{FE}(2)$	$V_{CE}=6V, I_C=400mA$	25	--	--	
Collector-Emitter Saturation Voltage	$V_{CE(sat)}$	$I_C=500mA, I_B=50mA$	--	--	0.6	V
Base-Emitter Voltage	V_{BE}	$V_{CE}=1V, I_C=100mA$	--	0.8	1.0	V
Transition Frequency	f_T	$V_{CE}=6V, I_C=20mA$	150	300	--	MHz
Collector Output Capacitance	C_{ob}	$V_{CB}=6V, I_E=0,$ $f=1MHz$	--	7.0	10	pF

Typical Performance Characteristics

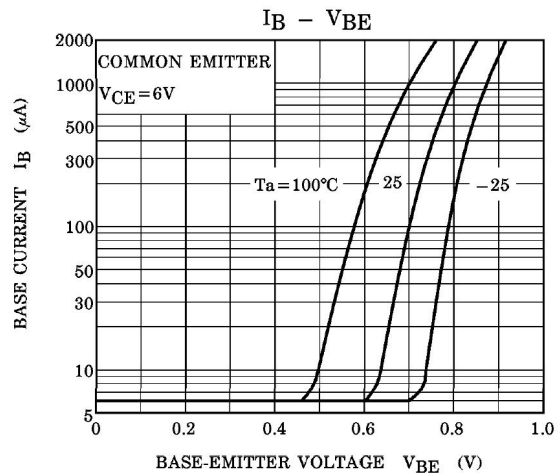
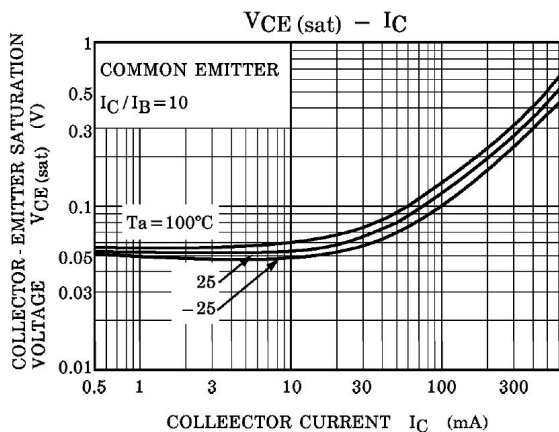
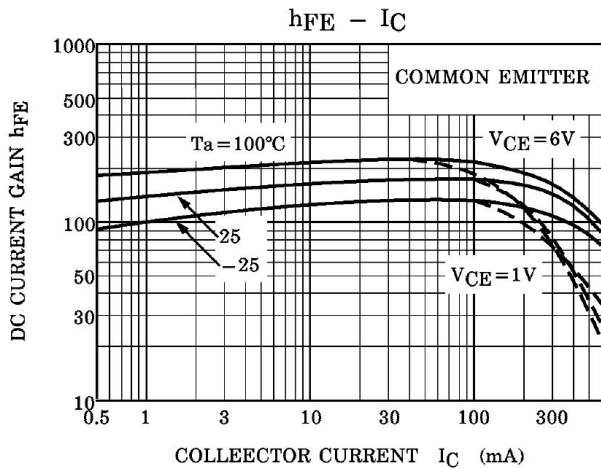
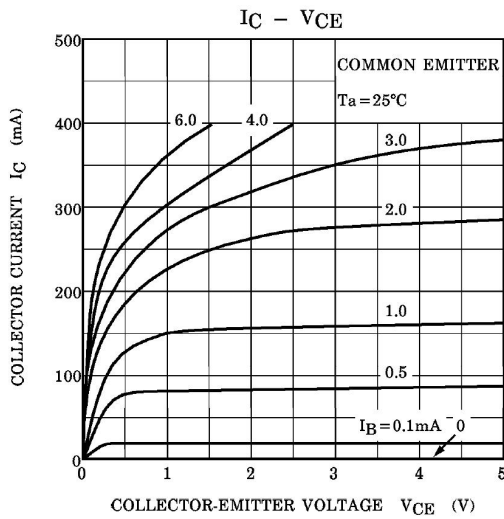

Note: Specifications are subject to change without notice. For more detail and update, please visit our website.